

Gete Plus Sealing Solution

Product Range



Gete⁺



D.I.Y. Door Seal Range

At Gete Plus Sealing Solution products, we are pleased to offer a range of Door Seals to complement our comprehensive Weather Seals Range. Gete Plus Door Seals are designed to protect the home by creating a barrier under external and internal doors. This extensive range operates efficiently on either carpeted surfaces, Polished timber floors and rough or smooth tiled areas.

Gete Plus Door Seals are offered in a variety of styles, colors and configurations. These Door Seals are manufactured from the highest quality raw materials and are available in both self-adhesive and screw-on fixing application.



GDS1



GDS2&2A



GDS3



GDS4



GDS5



GDS8



GDS9



GDS10



GDS11

Door Seals-Strips



GDS1 Vinyl Door Seal

Part no.	UPC#Bar code	Color	Size	Inner Box	Carton
G-71302	4710374467120	White	915 X 37mm	6PCS	60PCS/ Cu.ft2.6'
G-72302	4710374467229	Brown			
G-73302	4710374467328	Clear			
G-71802	4710374467137	White	1200 X 37mm		60PCS/ Cu.ft3.3'
G-72802	4710374467236	Brown			
G-73802	4710374467335	Clear			

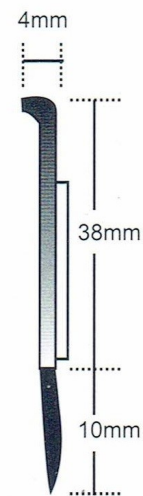

Product Features: The GDS1 Vinyl Door Seal is a surface mounted sweep type made of a flexible extrusion of plastic. It is suitable for sliding and swinging doors. The installation is simple and does not require the door to be removed.

Location: Door bottom or sliding door edge.

Sealing Gap: 3mm ~ 10mm

Product length: 915mm & 1200mm(can be cut to desired length)

Seal Material: Modified PVC (Color available: White, Brown & Clear)

GDS2 & GDS2A Thrifty Door Seal

Part no.	UPC#Bar code	Color	Size	Inner Box	Carton	
G-65301	4710374465317	Bronze	915 X 40mm	6PCS	60PCS/ Cu.ft2.6'	
G-66301	4710374466314	Silver				
G-65302	4710374463023	Bronze	915 X 60mm		60PCS/ Cu.ft2.85'	
G-66302	4710374466321	Silver				
G-66312	4710374460220	Silver	915 X 75mm			60PCS/ Cu.ft2.9'
G-66811	4710374460237	Silver	1200 X 60mm			
G-66812	4710374460244	Silver	1200 X 75mm			

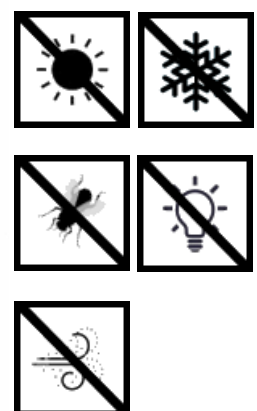
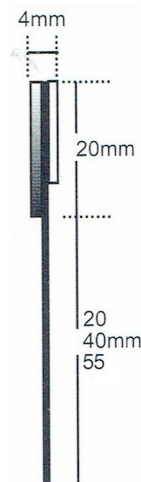

Product Features: The GDS 2 & 2A Thrifty Door Seal is a surface mounted sweep type made of an Aluminum extrusion and EVA material. This Door Seal is suitable for sliding and swinging doors. The installation is simple and does not require the door to be removed.

Location: Door bottom or sliding door edge.

Sealing Gap: 3mm ~ 15mm(GDS2) ; 13mm ~ 55mm(GDS2A)

Product length: 915mm & 1200mm(can be cut to desired length)

Seal Material: Modified EVA material (Black)

Door Seals-Strips



GDS3 Aluminum Door Seal

Part no.	UPC#Bar code	Color	Size	Inner Box	Carton
G-65306	4710374465362	Bronze	915 X 37mm	6PCS	60PCS/ Cu.ft2.6'
G-66306	4710374466369	Silver			
G-67306	4710374466673	Gold			



Product Features: The GDS 3 Aluminum Door Seal is a surface mounted sweep type made of an Aluminum extrusion and synthetic Rubber material. This Door Seal is suitable for sliding and swinging doors. The installation is simple and does not require the door to be removed.

Location: Door bottom or sliding door edge.

Sealing Gap: 5mm ~ 15mm

Product length: 915mm (can be cut to desired length)

Seal Material: Molded synthetic Rubber material (Black)

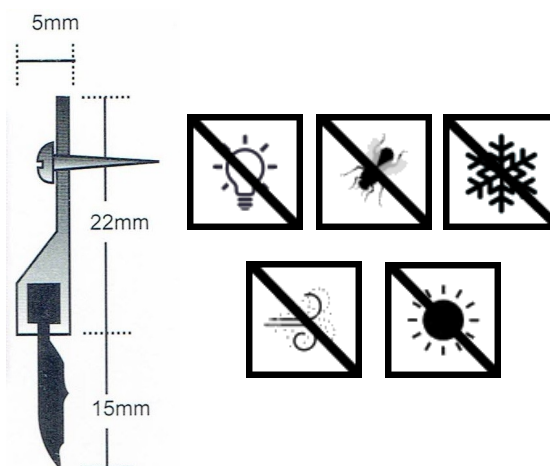

GDS4 Vinyl Brush Door Seal

Part no.	UPC#Bar code	Color	Size	Inner Box	Carton
G-65304	4710374465348	Clear	915 X 42mm	6PCS	60PCS/ Cu.ft2.6'
G-66304	4710374466345	Brown			
G-67304	4710374467342	White			
G-65804	4710374460206	Clear	1200 X 42mm	6PCS	60PCS/ Cu.ft3.3'
G-66804	4710374460107	Brown			
G-67804	4710374460008	White			



Product Features: The GDS 4 Vinyl Brush Door Seal is a surface mounted sweep type made of a PVC extrusion and synthetic brush material. This Door Seal is suitable for sliding and swinging doors. The installation is simple and does not require the door to be removed. It is especially suitable for rough textured floor surface such as slate or un-even tiles.

Location: Door bottom or sliding door edge.

Sealing Gap: 10mm ~ 20mm

Product length: 915 & 1200mm (can be cut to desired length)

Seal Material: Modified synthetic Brush material (Black)

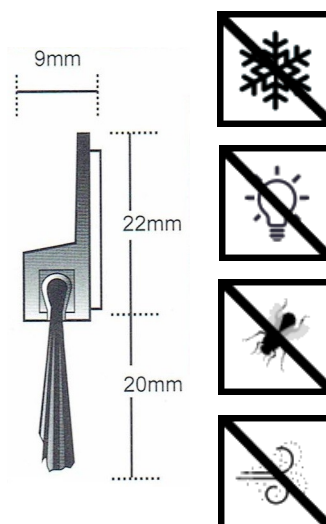

Door Seals-Strips



GDS5 Aluminum Brush Door Seal

Part no.	UPC#Bar code	Color	Size	Inner Box	Carton
G-65305	4710374465355	Bronze	915 X 42mm	6PCS	60PCS/ Cu.ft2.6'
G-66305	4710374466352	Silver			
G-67305	4710374466406	Gold			



Product Features: The GDS 5 Aluminum Brush Door Seal is a surface mounted sweep type made of an Aluminum extrusion and synthetic brush material. This Door Seal is suitable for sliding and swinging doors. The installation is simple and does not require the door to be removed. It is especially suitable for rough textured floor surface such as slate or un-even tiles.

Location: Door bottom or sliding door edge.

Sealing Gap: 10mm ~ 20mm

Product length: 915mm (can be cut to desired length)

Seal Material: Modified synthetic Brush material (Black)

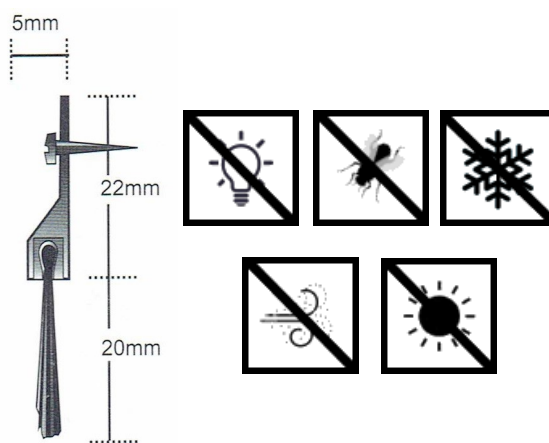

GDS8 Slender Automatic Door Seal

Part no.	UPC#Bar code	Color	Size	Inner Box	Carton
G-65308	4710374466413	Bronze	915 X 42mm	6PCS	48PCS/ Cu.ft2.5'
G-66308	4710374466383	Silver			
G-67308	4710374466789	Gold			



Product Features: The GDS 8 Slender Automatic Door Seal is a surface mounted automatic lifting type made of an Aluminum extrusion and molded synthetic Rubber material. This Door Seal is suitable for swinging doors. The installation is simple and does not require the door to be removed.

Location: Door bottom edge.

Sealing Gap: 3mm ~ 17mm

Product length: 915mm (can be cut to desired length)

Seal Material: Molded synthetic Rubber material (Grey)

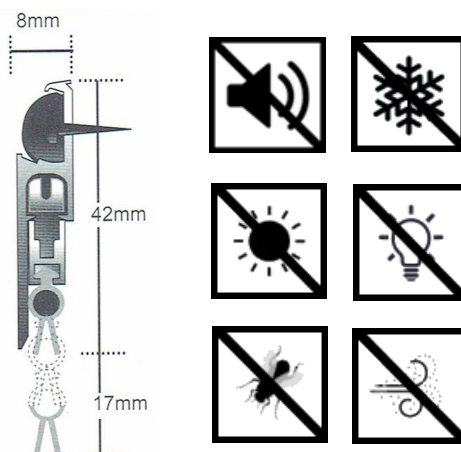

Door Seals-Strips



GDS9 Universal Door Seal

Part no.	UPC#Bar code	Color	Size	Inner Box	Carton
G-65309	4710374466376	Bronze	915 X 50mm	6PCS	24PCS/ Cu.ft3.1'



Product Features: The GDS 9 Universal Door Seal is a two pieces surface and floor mounted sealing system made of an Aluminum extrusion and molded synthetic Rubber material. This Door Seal is suitable for sliding and swinging doors. The installation is simple and does not require the door to be removed.

Location: Door bottom edge.

Sealing Gap: 3mm ~ 15mm

Product length: 915mm (can be cut to desired length)

Seal Material: Molded synthetic Rubber material (Grey)

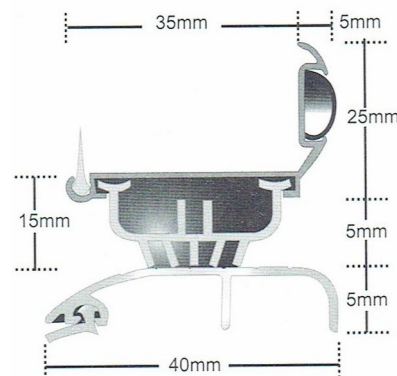

GDS10 Invisible Automatic Door Seal

Part no.	UPC#Bar code	Color	Size	Inner Box	Carton
G-66310	4710374463108	Silver	915 X 35mm	6PCS	24PCS/ Cu.ft2.3'



Product Features: The GDS 10 Invisible Automatic Door Seal is a internally mounted sealing system made of an Aluminum extrusion and molded synthetic Rubber material. This Door Seal is suitable for swinging doors. The installation is simple and does not require the door to be removed.

Location: Internally within mortised Door bottom.

Sealing Gap: 3mm ~ 15mm

Product length: 915mm (can be cut to desired length)

Seal Material: Molded synthetic Rubber material (Grey)

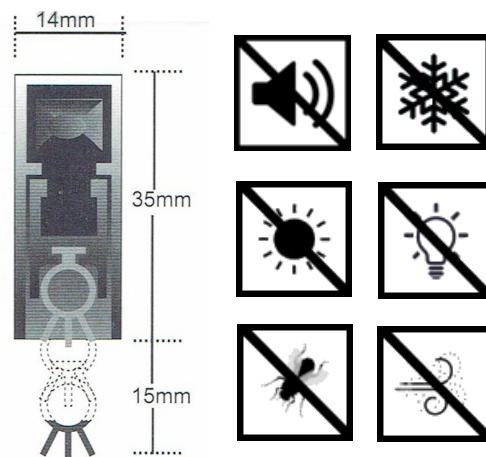

Door Seals-Strips



GDS11 Shady Automatic Door Seal

Part no.	UPC#Bar code	Color	Size	Inner Box	Carton
G-65331	4710374461111	Bronze	915 X 60mm	6PCS	24PCS/ Cu.ft2.3'
G-66331	4710374461128	Silver			
G-67331	4710374466338	Gold			

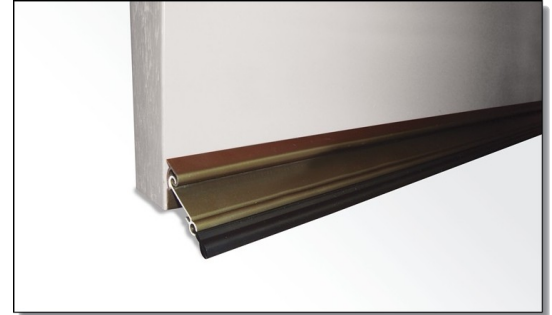

Product Features: The GDS 11 Shady Automatic Door Seal is a surface mounted automatic lifting type made of an Aluminum extrusion and molded synthetic Rubber material. This Door Seal is suitable for swinging doors. The installation is simple and does not require the door to be removed.

Location: Door bottom edge.

Sealing Gap: 3mm ~ 12mm

Product length: 915mm (can be cut to desired length)

Seal Material: Molded synthetic Rubber material (Black)

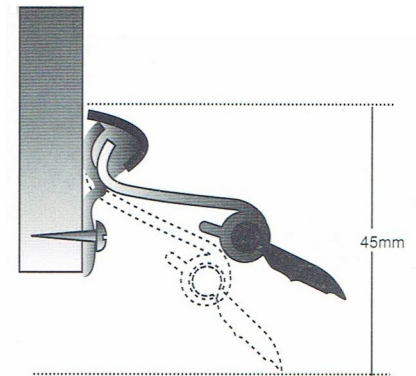



D.I.Y. Weather Seal Range

At Gete Plus Sealing Solution products, we have been producing Weather Seals for the D.I.Y market for a number of years and are renowned for our comprehensive range of Polyurethane, PVC, EPDM and PP Brush material Weather Seals. These products are available in handy 5meters Retail packing a variety of colors to suit most decor and window or door frame applications.



Gap Filler



Xpecial-Seal



Brush-Seal



Ductile-Seal



Poly-Seal



Weather Seals



Why using flexible closed cell foam seal?

The closed cell foam can create a waterproof barrier when compressed, while still being flexible enough to seal uneven surfaces. The higher density foam has a greater resistance to water penetration than lower ones, making it the ideal choice for sealing application in the glazing market. Which is very beneficial in flooding zones. Closed cell foam is defined as a cell totally enclosed by its walls and hence not interconnecting with other cells. Closed cell foam is usually made by subjecting a rubber compound to a gas such as nitrogen, under high pressure. The type of material is ideal for sealing as it effectively reduces liquid and gas flow. Moisture penetration. Closed cell foam is an incredible product below grade in your basement or crawl space because of its ability to block moisture. You'll also see closed cell used in commercial and industrial projects, pole barns, metal building, and exterior application.

At a thickness of 1.5", many closed cell products can provide a moisture barrier to reject bulk water, and its these vapor permeability characteristics that make closed cell products perfect for insulating basement and crawl space walls. It will completely lock out the damp, musty, humid smells most basement have to fight.



Weather Seals



Part no.	UPC#Bar code	Color	Size	Inner Box	Carton
G-21102	4710374467670	White	4.8mm X 9mm X 5M	12PCS	60PCS/ Cu.ft1.71'
G-22102	4710374467694	Brown			
G-23102	4710374467717	Grey			
G-21301	4710374468455	White	4.8mm X 9mm X 100M	1PCS	5PCS/ Cu.ft3.27'
G-22301	4710374468462	Brown			
G-23301	4710374468479	Grey			

GWS3 Poly-Seal



Product Features: The GWS 3 Poly-SEAL is self-adhesive surface mounted weather seal made of flexible soft density PVC closed cell foam. The closed cell foam can create a waterproof barrier when compressed, while still being flexible enough to seal uneven surfaces. The higher density foam has a greater resistance to water penetration. These products have three variety colors to suit most décor window or door frame application. The installation is simple and does not require the door/window to be removed.

Location: Door and Window jamb.

Sealing Gap: 2.5mm – 4.8mm

Product Length: 5 & 100meters (can be cut to desired length)

Seal Material: Closed Cell Foam (Brown, Grey and White)

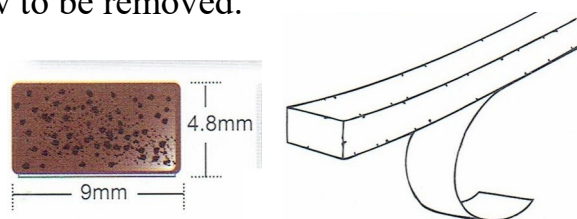

Part no.	UPC#Bar code	Color	Size	Inner Box	Carton
G-31102	4710374467427	White	6 X 9mm X 5M	12PCS	60PCS/ Cu.ft1.71'
G-33102	4710374467465	Grey			
G-31401	4710374467434	White	12 X 12mm X 2.5M		60PCS/ Cu.ft2.2'
G-33401	4710374467526	Grey			
G-31402	4710374467441	White	6 X 19mm X 5M		60PCS/ Cu.ft3.2'
G-33402	4710374467533	Grey			
G-31403	4710374467458	White	6 X 25mm X 5M		60PCS/ Cu.ft3.7'
G-33403	4710374467540	Grey			

GWS4 Thrifty-Seal

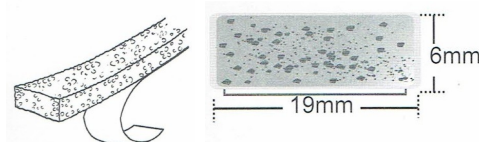

Product Features: The GWS 4 Thrifty-Seal is a Self-Adhesive surface mounted weather seal made of flexible Open Cell Foam. This multiple use seal is suitable for a multitude of domestic and commercial applications. The installation is simple and does not require the door/window to be removed.

Location: Edges and jambs

Sealing Gap: Up to 6mm and 12mm

Product Length: 2.5 & 5meters (can be cut to desired length)

Seal Material: Open Cell Polyurethane Foam (Grey and White)

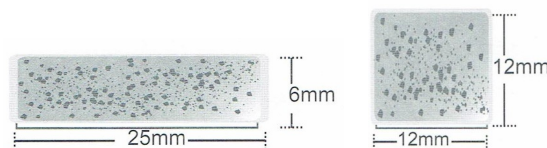

Weather Seals



Part no.	UPC#Bar code	Color	Size	Inner Box	Carton
G-28301	4710374468486	Black	4.8 X 25mm X 30M	1PCS	5PCS/ Cu.ft3.27'
G-28103	4710374467731	Black	6.4 X 25mm X 3M	6PCS	30PCS/ Cu.ft1.8'
G-28104	4710374467748	Black	12.7 X 25mm X 3M	6PCS	30PCS/ Cu.ft2.7'
G-28105	4710374467755	Black	19 X 25mm X 3M	6PCS	30PCS/ Cu.ft4.2'
G-28501	4710374467793	Black	4.8 X 25mm X 10M	6PCS	30PCS/ Cu.ft2.9'

GWS5 Talented-Seal SOFT Multi Purpose Seals



Product Features: The GWS 5 Talented-SEAL is self-adhesive surface mounted weather seal made of flexible soft density PVC closed cell foam. The closed cell foam can create a waterproof barrier when compressed, while still being flexible enough to seal uneven surfaces. The higher density foam has a greater resistance to water penetration. This multiple use seal is suitable for a multitude domestic and commercial application. The installation is simple and does not require the door/window to be removed.

Location: Edges and jambs.

Sealing Gap: Up to 4.8mm, 6.4mm, 12.7mm and 19mm

Product Length: 3, 10, 30, 75meters (can be cut to desired length)

Seal Material: Closed Cell PVC Foam (Black)

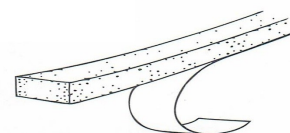

Part no.	UPC#Bar code	Color	Size	Inner Box	Carton
G-28302	4710374467311	Black	4.8 X 25mm X 30M	1PCS	5PCS/ Cu.ft3.27'
G-28502	4710374467809	Black	4.8 X 25mm X 10M	6PCS	30PCS/ Cu.ft2.9'

GWS6 Talented-Seal Medium Multi Purpose Seals

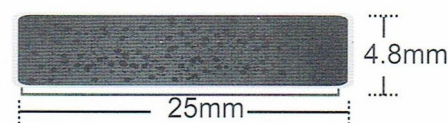

Product Features: The GWS 6 Talented-Seal is self-adhesive surface mounted weather seal made of flexible **Medium** density PVC closed cell foam. The closed cell foam can create a waterproof barrier when compressed, while still being flexible enough to seal uneven surfaces. The higher density foam has a greater resistance to water penetration. This weather seal is suitable for domestic and commercial (industrial project), pole barn, metal building and exterior application. The installation is simple and does not require the door/window to be removed.

Location: Edges and jambs.

Sealing Gap: Up to 4.8mm.

Product Length: 10, 30, 75meters (can be cut to desired length)

Seal Material: Closed Cell PVC Foam (Black)

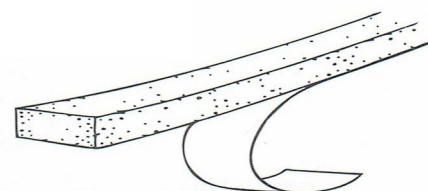

Weather Seals



Part no.	UPC#Bar code	Color	Size	Inner Box	Carton
G-28303	4710374467304	Black	4.8 X 25mm X 30M	1PCS	5PCS/ Cu.ft3.27'
G-28503	4710374467816	Black	4.8 X 25mm X 10M	6PCS	30PCS/ Cu.ft2.9'

Product Features: The GWS 7 Talented-Seal is self-adhesive surface mounted weather seal made of flexible **HARD** density PVC closed cell foam. The closed cell foam can create a waterproof barrier when compressed, while still being flexible enough to seal uneven surfaces. The higher density foam has a greater resistance to water penetration. This weather seal is suitable for domestic and commercial (industrial project), pole barn, metal building and exterior application. The installation is simple and does not require the door/window to be removed.

Location: Edges and jambs.

Sealing Gap: Up to 4.8mm.

Product Length: 10, 30, 75meters (can be cut to desired length)

Seal Material: Closed Cell PVC Foam (Black)

GWS7 Talented-Seal HARD Multi Purpose Seals

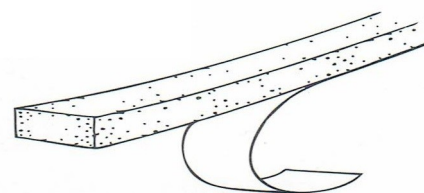
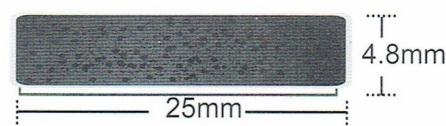

Part no.	UPC#Bar code	Color	Size	Inner Box	Carton
G-43205	4710374467564	Grey	6.7 X 5mm X 100M	1PCS	5PCS/ Cu.ft3.27'
G-43102	4710374467557	Grey	6.7 X 5mm X 5M	12PCS	60PCS/ Cu.ft1.72'

GWS8 Brush-Seal

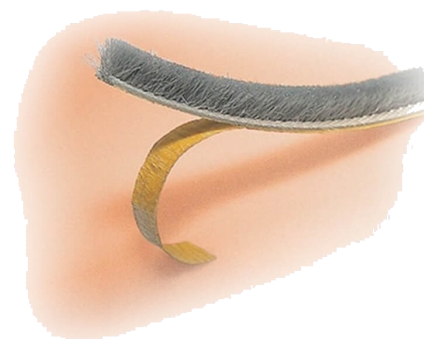

Product Features: The GWS 8 Brush-Seal is a Self-Adhesive surface mounted weather seal made of flexible extrusion of PP brush material. This weather seal is suitable for domestic and commercial doors and windows. The installation is simple and does not require the door/window to be removed.

Location: Door and window jambs.

Sealing Gap: 3mm-5mm

Product Length: 5 & 100meters (can be cut to desired length)

Seal Material: PP brush (Grey)

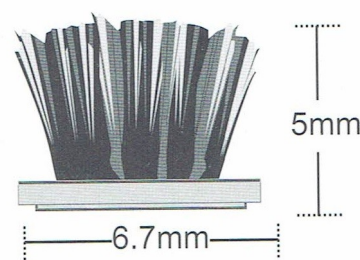

Weather Seals



Part no.	UPC#Bar code	Color	Size	Inner Box	Carton
G-12205	4710374467656	Brown	6 X 9mm X 200M Profession	1PCS	5PCS/ Cu.ft3.27'
G-11205	4710374467601	White			
G-12305	4710374468448	Brown	6 X 9mm X 100M Profession	1PCS	3PCS/ Cu.ft3.27'
G-11305	4710374467625	White			
G-12112	4710374467632	Brown	6 X 9mm X 5M Profession	12PCS	60PCS/ Cu.ft2.12'
G-11112	4710374467588	White			
G-22112	4710374462217	Brown	5.5 X 9mm X 5M		
G-21112	4710374462118	White			

GWS11 EPDM P Profile Xpecial-Seals



Product Features: The GWS 11 EPDM Xpecial Seal is self-adhesive surface mounted weather seal made of a flexible of EPDM Rubber. This weather seal is suitable for domestic and commercial doors or windows. The installation is simple and does not require the door/window to be removed.

Location: Door and Window jamb.

Sealing Gap: 3mm – 5mm

Product Length: 5, 100, 200meters (can be cut to desired length)

Seal Material: EPDM rubber (Brown and White)

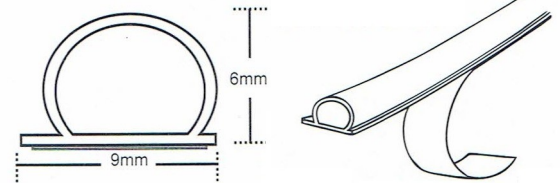

Part no.	UPC#Bar code	Color	Size	Inner Box	Carton
G-12304	4710374467663	Brown	4.5 X 8mm X 100M Profession	1PCS	5PCS/ Cu.ft3.27'
G-11304	4710374467618	White			
G-12123	4710374467649	Brown	4.5 X 8mm X 5M Profession	12PCS	60PCS/ Cu.ft2.12'
G-11123	4710374467595	White			

GWS12 EPDM U Profile Xpecial-Seals



Product Features: The GWS 12 EPDM Xpecial Seal is self-adhesive surface mounted weather seal made of a flexible of EPDM Rubber. This weather seal is suitable for domestic and commercial doors or windows. The installation is simple and does not require the door/window to be removed.

Location: Door and Window jamb.

Sealing Gap: 2mm – 4mm

Product Length: 5 & 100meters (can be cut to desired length)

Seal Material: EPDM rubber (Brown and White)

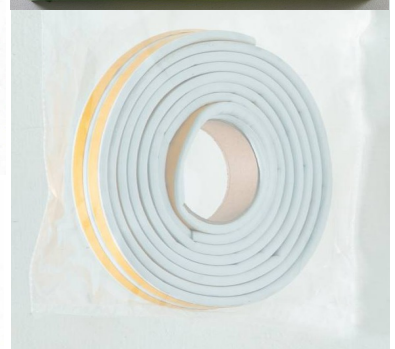
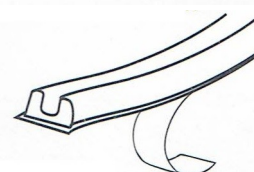
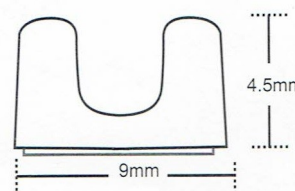

Weather Seals



GWS9 Ductile-Seal Multi Purpose Seals

Product Features: The GWS 9 Ductile-Seal is a Soft Density Self-Adhesive surface mounted weather seal made of flexible Closed Cell Foam. This weather seal is suitable for domestic roofing and outdoor applications. The installation is simple and does not require the door/window to be removed.

Location: Ideal for roofing purlins and battens

Sealing Gap: Up to 4.5mm and 6mm

Product Length: 10meters (can be cut to desired length)

Seal Material: Closed Cell Polyethylene Foam



Part no.	UPC#Bar code	Color	Size	Inner Box	Carton
G-81103	4710374467359	White	4.5 X 25mm X 10M	6PCS	30PCS/ Cu.ft2.9'
G-82103	4710374468561	Black	6 X 18mm X 10M	12PCS	60PCS/ Cu.ft5.2'

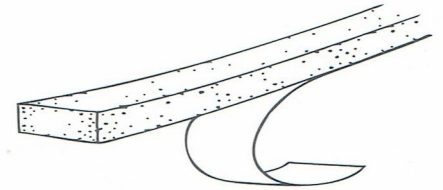

Part no.	UPC#Bar code	Color	Size	Inner Box	Carton
G-81210	4710374467366	White	Dia.15mm X 5M	12PCS	24PCS/ Cu.ft3.17'
G-81219	4710374467380		Dia.10mm X 5M		24PCS/ Cu.ft1.72'
G-81217	4710374467373		Dia.6mm X 5M		48PCS/ Cu.ft1.71'
G-81304	4710374467397		Dia.15mm X 25M	1PCS	12PCS/ Cu.ft4.3'
G-81305	4710374467403		Dia.10mm X 50M		
G-81306	4710374467410		Dia.6mm X 100M		

GGF Gap Filler Rod



The GGF1/GGF2/GGF3 Gap Filler Rod is a 15mm/10mm/6mm Diameter flexible extrusion of Open Cell Foam.

This backing rod is suitable for domestic and commercial application where deep cracks or gap need to be filled in conjunction with caulking product.

Location: Any deep crack or gap

Sealing Gap: Up to 15mm

Product Length: 5, 25, 50, 100meters (to be cut in desired length)

Seal Material: Extruded Polyethylene Foam (White)

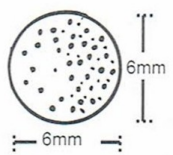
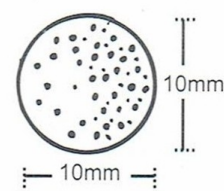
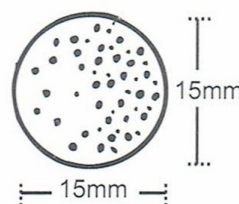



D.I.Y. General Purpose Range

Gete Plus Sealing Solution products also produce a range of Slip strips, Scratch Savers, Energy Seals, Protection foam and the new Reflection/Warning stripes/spots product.



Safety Goggles Range

Safety and sporty, modern, chic & retro are the top priorities with Gete Safety branded personal shielded belongings and all other applicable health and safety standards, as well as all user instructions, warnings and limitations accompanying each product. It is essential that all product user instructions and government regulations on the use of each product be followed in order for the product to help protect the wearer. Misuse of personal protective equipment may result in injury, sickness, or death. You can rely on Gete Safety for the solutions required to protect your employees and important jobs.



D.I.Y. Hook & Loop Range

Gete Plus products are pleased to announce the introduction of the new Power-Grip range of Quality Hook and Loop products. This range has been designed to offer the retailer a choice of options with greater quantities while still offering a realistic fast moving retail price point.



Edge & Corner Protection Foam



Edge & Corner Protection Foam



GCP1 & GCP3 Self Adhesive Corner Protection Foam

Part no.	UPC#Bar code	Color	Size	Inner Box	Carton
G-30010	4710374468288	Brown	20~22 X 5T X 55mm X 4PCS	12SETS	120SETS/ Cu.ft2.7'
G-30015	4710374468295	Yellow			
G-30020	4710374468301	Black			
G-30022	4710374468318	Grey			
G-30011	4710374468363	Black	20~22 X 5T X 55mm X 12PCS	6SETS	60SETS/ Cu.ft4.7'
G-30012	4710374468370	Brown			
G-30014	4710374468387	Grey			

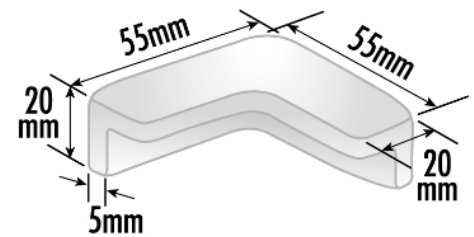

Product Features: Self Adhesive corner protection foam, designed to protect you and your children from hurting yourselves. Apply to sharp corners: Tables, Desk, Glass, Cupboards etc.

GEP2 & GEP4 Self Adhesive Edge Protection Foam

Part no.	UPC#Bar code	Color	Size	Inner Box	Carton
G-30025	4710374468325	Brown	20~22 X 5T X 915mm	6PCS	60PCS/ Cu.ft3'
G-30030	4710374468332	Yellow			
G-30035	4710374468349	Black			
G-30037	4710374468356	Grey			
G-30026	4710374468394	Black	20~22 X 5T X 5M	6PCS	30PCS/ Cu.ft2.74'
G-30027	4710374468424	White			
G-30028	4710374468400	Brown			
G-30029	4710374468417	Grey			
G-30031	4710374468431	Yellow			

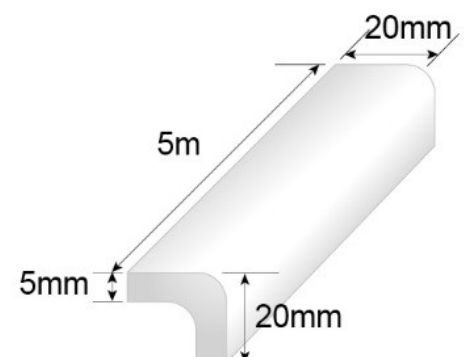

Product Features: Self Adhesive corner protection foam, designed to protect you and your children from hurting yourselves. Apply to sharp corners: Tables, Desk, Glass, Cupboards etc.

Protection Foam



GUP3 Universal Self Adhesive Warning/Protection Foam

Part no.	UPC#Bar code	Color	Size	Inner Box	Carton
G-20004	4710374468196	Black/Yellow	15cm X 115cm X 8mm	6PCS	36PCS/ Cu.ft3.93'



GSS2 Interlocking Foam Floor Mats

Part no.	UPC#Bar code	Color
G-30007	4710374468530	Wood Figure
Size	32cm X 32cm X 2cm X 4PCS	

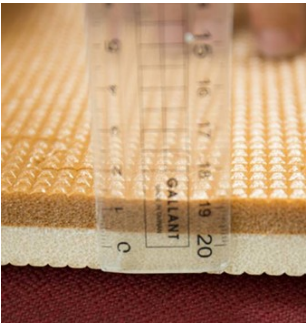
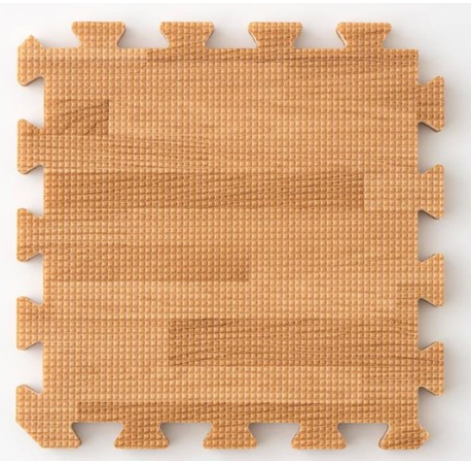

Wall Protection Foam



Wall Protection Foam

Part no.	UPC#Bar code	Color	Style	Size	Carton
G-9221	4710374469216	Grey	Brick Look	30cm X 60cm X 13mm X 4PCS	20Bags/Cu.ft6.73'
G-9222	4710374469223	White			
G-9223	4710374469230	Brown			
G-9225	4710374469254	Black			
G-9224	4710374469247	Wood Figure	Parquet Look		
G-9226	4710374469261	Black	Mosaic Look		
G-9227	4710374469278	Grey	Pyramid Look	30cm X 60cm X 19mm X 4PCS	20Bags/Cu.ft9.83'

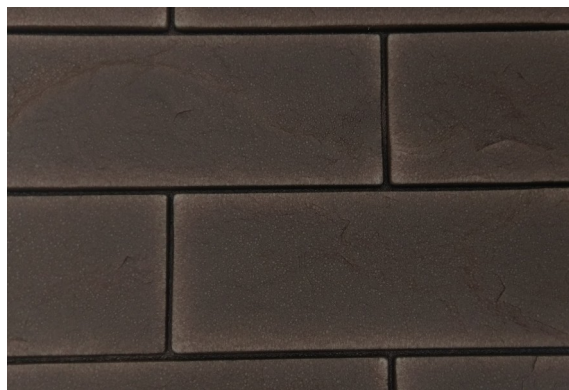

Brick Look



Parquet Look

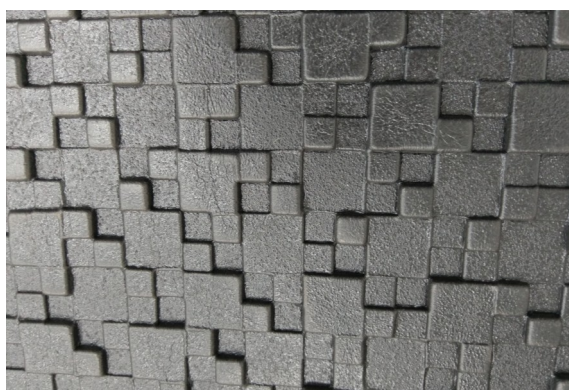

Mosaic Look

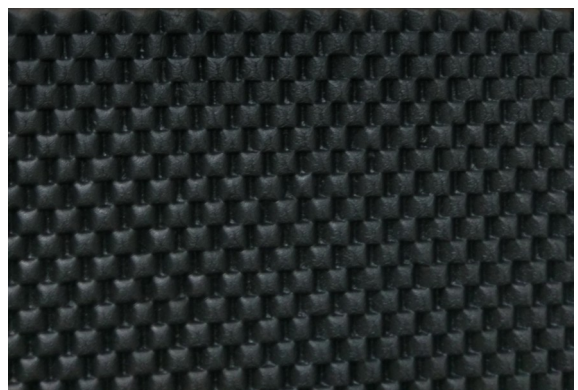

Pyramid Look

Scratch Saver



GUP1 & GUP2 Self Adhesive Seal Roll

Part no.	UPC#Bar code	Color	Size	Inner Box	Carton
G-20001	4710374468202	Black	40mm X 5M X 3mm	6PCS	60PCS/ Cu.ft3.03'
G-20002	4710374468219		100mm X 5M X 3mm		30PCS/ Cu.ft3.25'

Product Features: Furniture Guard Strips, Airtight Seal Strips, Packing and Cushioning, Air Conditioning and Thermal Insulation, Closed Cell Foam good for waterproof.

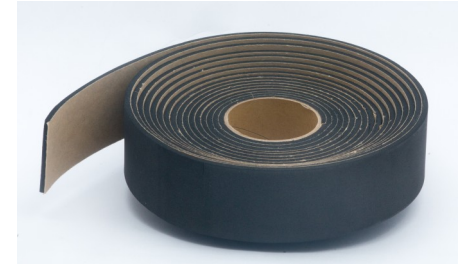

GSS1 Scratch Saver Self Adhesive Felt Tape

Part no.	UPC#Bar code	Color	Size	Inner Box	Carton
G-48102	4710374467571	Black	40mm X 1M X 3mm	12PCS	120PCS/ Cu.ft3.3'
G-48104	4710374468547	Black	25mm X 3M X 3mm	12PCS	120PCS/ Cu.ft4.6'
G-48105	4710374468554	Black	40mm X 10M X 3mm	6PCS	30PCS/ Cu.ft3'

Product Features: Scratch Saver Felt Tape is a high quality Blended Fibers Felt Protector. It Protects polished surfaces from scratching and reduces noises. Scratch Saver Felt Tape allows furniture and heavy objects to be moved across polished wood and tile floors silently and without scratching. It also protects desks and table tops from damage by computers, vases, etc.



Reflection Spots/Strips



GVS1 & GVS4 Self Adhesive Visible Spots

Part no.	UPC#Bar code	Color	Size	Inner Box	Carton
G-01701	4710374468158	Red	Ø60mm X 6PCS	12SETS	120SETS/ Cu.ft1.08'
G-01704	4710374468189	Neon Orange			

GETE Well-qualified Grade Sticker Made by PET, UV-resistance material, Waterproof, All-Weather, Outdoor High Visibility Sticker for Safety Requirements.

Construction, utility, police, emergency medical services, fire fighters and airport ramp workers are routinely exposed to the hazards of low visibility while on the job. Our stickers provides for the selection and use of high-visibility safety apparel such as shirts, rainwear, outerwear, safety vests and headwear to improve worker visibility during the day, in low-light conditions and at night.

We guaranteed high visibility in all weather conditions.

Our sticker is made by PET, UV- resistance material.

The sticker is 100% waterproof.

The sticker is durable and long-lasting. It is suitable for outdoor use.



GVS2 & GVS3 Self Adhesive Visible Strips

Part no.	UPC#Bar code	Color	Size	Inner Box	Carton
G-01702	4710374468165	Neon Yellow	48mm X 300mm X 4PCS	12SETS	120SETS/ Cu.ft1.45'
G-01703	4710374468172	Red/White			

GETE Well-qualified Grade Sticker Made by PET, UV-resistance material, Waterproof, All-Weather, Outdoor High Visibility Sticker for Safety Requirements.

Construction, utility, police, emergency medical services, fire fighters and airport ramp workers are routinely exposed to the hazards of low visibility while on the job. Our stickers provides for the selection and use of high-visibility safety apparel such as shirts, rainwear, outerwear, safety vests and headwear to improve worker visibility during the day, in low-light conditions and at night.

We guaranteed high visibility in all weather conditions.

Our sticker is made by PET, UV- resistance material.

The sticker is 100% waterproof.

The sticker is durable and long-lasting. It is suitable for outdoor use.



Reflection Spots/Strips



GVS5 Self Adhesive Visible Spots & Strips

Part no.	UPC#Bar code	Color	Size	Inner Box	Carton
G-01705	4710374467052	Neon Yellow Red	48mm X 300mm X 3PCS Ø60mm X 5PCS	12SETS	120SETS/ Cu.ft1.08'

GETE Well-qualified Grade Sticker Made by PET, UV-resistance material, Waterproof, All-Weather, Outdoor High Visibility Sticker for Safety Requirements.

Construction, utility, police, emergency medical services, fire fighters and airport ramp workers are routinely exposed to the hazards of low visibility while on the job. Our stickers provides for the selection and use of high-visibility safety apparel such as shirts, rainwear, outerwear, safety vests and headwear to improve worker visibility during the day, in low-light conditions and at night.

We guaranteed high visibility in all weather conditions.

Our sticker is made by PET, UV- resistance material.

The sticker is 100% waterproof.

The sticker is durable and long-lasting. It is suitable for outdoor use.



Anti Slip Strips



GAS5 Anti Slip Strips

Part no.	UPC#Bar code	Color	Size	Inner Box	Carton
G-28246	4710374468264	Black/Yellow	65mm X 300mm X 3PCS	12SETS	120SETS/ Cu.ft1.45'



GAS6 Anti Slip Strips

Part no.	UPC#Bar code	Color	Size	Inner Box	Carton
G-28645	4710374468271	White	19mm X 431mm X 7PCS	12SETS	120SETS/ Cu.ft1.26'

Water proof.
Self adh for bathtub.



Rubber Energy Seals



Rubber Rectangle Energy Seals

Part no.	UPC#Bar code	Color	Size	Inner Box	Carton
G-51002	4710374468578	Black	1.5mm X 38mm X 5M	6PCS	24PCS/ Cu.ft0.98'

Performance: Working temperature: -40°C degree to 100°C degree with the feature of oil proof, weather-ability and anti-aging.

Usage: Waterproof material to be used as washer and sealing fitting in high common required area.



Sponge Rubber Rectangle Energy Seals

Part no.	UPC#Bar code	Color	Size	Inner Box	Carton
G-52003A	4710374468585	Black	3mm X 55mm X 3M	6PCS	60PCS/ Cu.ft2.9'
G-53002A	4710374468592	Black	4.5mm X 25mm X 3M	12PCS	60PCS/ Cu.ft1.97'
G-54002A	4710374468608	Black	6mm X 38mm X 3M	6PCS	36PCS/ Cu.ft2.37'

Performance: Working temperature: -40°C degree to 100°C degree with the feature of oil proof, weather-ability and anti-aging.

Usage: Waterproof material to be used as washer and sealing fitting in high common required area.



G-52003A



G-53002A

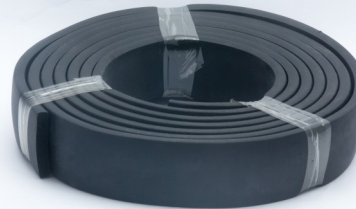

G-54002A

Sponge Rubber RND Energy Seals

Part no.	UPC#Bar code	Color	Size	Inner Box	Carton
G-57003A	4710374468615	Black	Ø9mm X 5M	6PCS	60PCS/ Cu.ft4.81'

Performance: Working temperature: -40°C degree to 100°C degree with the feature of oil proof, weather-ability and anti-aging.

Usage: Waterproof material to be used as washer and sealing fitting in high common required area.



Rubber D Shape Energy Seals

Part no.	UPC#Bar code	Color	Size	Inner Box	Carton
G-59001	4710374468622	Black	20mm X 20mm X 3M	6PCS	18PCS/ Cu.ft3.37'

Performance: Working temperature: -40°C degree to 100°C degree with the feature of oil proof, weather-ability and anti-aging.

Usage: Waterproof material to be used as washer and sealing fitting in high common required area.

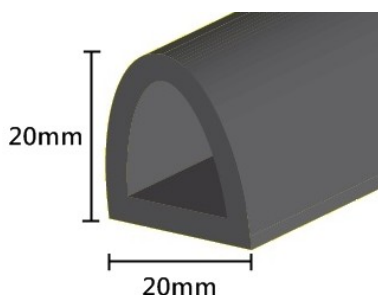

Rubber Energy Seals



Rubber U Shape Energy Seals

Part no.	UPC#Bar code	Color	Size	Inner Box	Carton
G-60001	4710374468639	Black	W 4mm X H 10mm X 5M	12PCS	60PCS/ Cu.ft1.08'
G-60002	4710374468646	Black	W 6mm X H 10mm X 5M	12PCS	60PCS/ Cu.ft1.69'
G-61001	4710374468653	Black	W 4mm X H 15mm X 5M	12PCS	60PCS/ Cu.ft1.61'

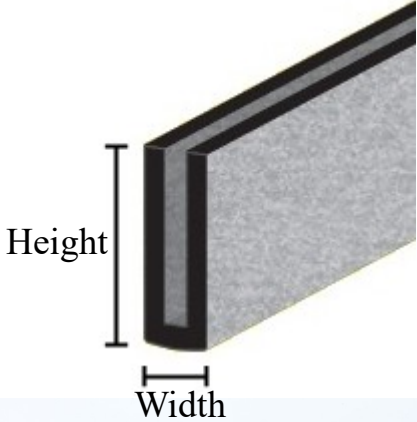

G-60001



G-60002



G-61001

Performance: Working temperature: -40°C degree to 100°C degree with the feature of oil proof, weather-ability and anti-aging.

Usage: Waterproof material to be used as washer and sealing fitting in high common required area.



Safety Goggles



G9001

Part no.	UPC#Bar code	Color	Inner Box	Carton
G9001B	4710374469018	Blue Lens/ Clear Frame	12PCS	300PCS/ Cu.ft4'
G9001BK	4710374469025	Black Lens/ Clear Frame		
G9001C	4710374469032	Clear Lens/ Clear Frame		
G9001LS	4710374469049	Light Silver Lens/Clear Frame		
G9001S	4710374469056	Silver Lens/ Clear Frame		
G9001Y	4710374469063	Yellow Lens/ Clear Frame		



Sporty design meets safety requirement. Polycarbonate lens are good for impact resistant and anti scratch. UV coating for protection. Nylon frame and rubber non-slip nose pad. Side temple pads for better fit. CE EN166+ UV400+ ANSI Z87.1

G9002

Part no.	UPC#Bar code	Color	Inner Box	Carton
G9002BK	4710374469070	Black Lens/ Black Frame	12PCS	300PCS/ Cu.ft5.7'
G9002C	4710374469087	Clear Lens/ Clear Frame		



Curving design with small side shield make secure and fashion. Polycarbonate lens are good for impact resistant and anti scratch. UV coating for protection. Nylon frame is good for durable and rage. CE EN166+ UV400+ ANSI Z87.1

G9003

Part no.	UPC#Bar code	Color	Inner Box	Carton
G9003B	4710374469186	Blue Lens/ Black Frame	12PCS	300PCS/ Cu.ft3.6'
G9003BK	4710374469094	Black Lens/ Black Frame		
G9003BR	4710374469100	Brown Lens/ Black Frame		
G9003C	4710374469117	Clear Lens/ Black Frame		



Frameless design, wide vision, light weight with small side shield make cool fashion. Polycarbonate lens are good for impact resistant and anti scratch. Anti slip nose pads and side temple pads are for better it. CE EN166+ UV400+ ANSI Z87.1

Safety Goggles



G9004

Part no.	UPC#Bar code	Color	Inner Box	Carton
G9004B	4710374469124	Blue Lens/ Black Frame	12PCS	300PCS/ Cu.ft4'
G9004BK	4710374469131	Black Lens/ Black Frame		
G9004C	4710374469148	Clear Lens/ Clear Frame		



Wide vision polarized lens, frameless design, light weight but durable.

Polycarbonate lens are good for impact resistant and anti scratch.

CE EN166+ UV400+ ANSI Z87.1

G9006

Part no.	UPC#Bar code	Color	Inner Box	Carton
G9006BK	4710374469193	Black Lens/ Black Frame	12PCS	300PCS/ Cu.ft3.8'
G9006C	4710374469209	Clear Lens/ Black Frame		



Curving design meets safety requirement.

Polycarbonate lens are good for impact resistant and anti scratch.

UV coating for protection.

Nylon frame and rubber non-slip nose pad.

Adjustable legs for better fit.

With rope.

CE EN166+ UV400+ ANSI Z87.1

G9007

Part no.	UPC#Bar code	Color	Inner Box	Carton
G9007BK	4710374469155	Black Lens/ Black Frame	12PCS	300PCS/ Cu.ft3.2'
G9007C	4710374469179	Clear Lens/ Black Frame		



Fashion design.

Polycarbonate lens are good for impact resistant and anti scratch.

Anti slip nose pads and side temple pads are for better fit.

CE EN166+ UV400+ ANSI Z87.1

Safety Goggles



G9011

Part no.	UPC#Bar code	Color	Inner Box	Carton
G9011CFBR	4710374469162	Brown Lens/ Camouflage Frame	12PCS	300PCS/ Cu.ft3.6'



Sporty design meets safety requirement.
 Polycarbonate lens are good for impact resistant and anti scratch.
 UV coating for protection.
 Nylon frame and rubber non-slip nose pad.
 Side temple pads for better fit.
 CE EN166+ UV400+ ANSI Z87.1



Hook & Loop



GVF1 Double Back

Part no.	UPC#Bar code	Color	Inner Box	Carton
G-08201	4710374468028	Black	12SETS	120SETS/ Cu.ft3.6'
G-01201	4710374467854	White		
Size		2 X 25mm X 1M X 2 Rolls		



GVF2 Self Adhesive

Part no.	UPC#Bar code	Color	Inner Box	Carton
G-08202	4710374468035	Black	12SETS	120SETS/ Cu.ft3.6'
G-01202	4710374467861	White		
Size		2 X 25mm X 1M X 2 Rolls		



GVF4 Self Adhesive Spots

Part no.	UPC#Bar code	Color	Inner Box	Carton
G-08204	4710374468042	Black	12SETS	120SETS/ Cu.ft3.6'
G-01204	4710374467878	White		
Size		Ø22mm X 24 Pr		

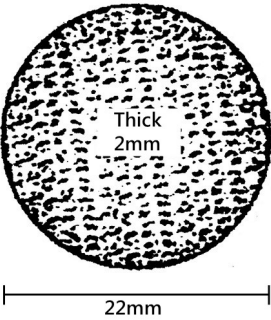

GVF5 Self Adhesive Strips

Part no.	UPC#Bar code	Color	Inner Box	Carton
G-08205	4710374468059	Black	12SETS	120SETS/ Cu.ft2.32'
G-01205	4710374467885	White		
Size		20mm X 150mm X 4 Pr		

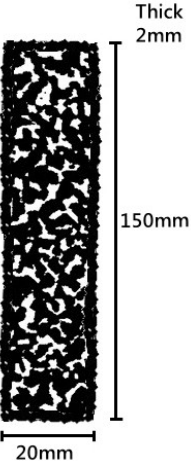

Hook & Loop



GVF6 Self Adhesive Tabs

Part no.	UPC#Bar code	Color	Inner Box	Carton
G-08206	4710374468066	Black	12SETS	120SETS/ Cu.ft2.11'
G-01206	4710374467892	White		
Size		25mm X 40mm X 12 Pr		

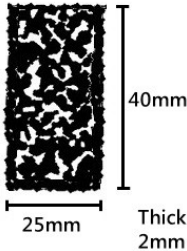

GVF23 Rough Surface Self Adhesive

Part no.	UPC#Bar code	Color	Inner Box	Carton
G-03005	4710374467960	Grey	12SETS	120SETS/ Cu.ft2.54'
Size		25mm X 100mm X 3 Pr		

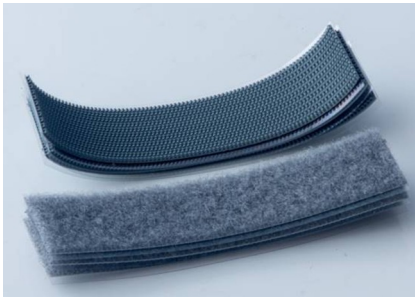

GVF51 Reusable Ties

Part no.	UPC#Bar code	Color	Inner Box	Carton
G-00201	4710374467823	Red, Blue, Yellow Green, Black	12SETS	120SETS/ Cu.ft2.23'
G-08200	4710374468011	Black		
Size		25mm X 200mm X 5PCS		

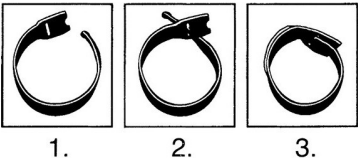

GVF7 Hook Only & GVF8 Loop Only

Part no.	UPC#Bar code	Color	Class	Inner Box	Carton
G-08107	4710374468493	Black	Hook	1PCS	10PCS/ Cu.ft1.52'
G-01107	4710374468509	White	Hook		
G-08108	4710374468516	Black	Loop		
G-01108	4710374468523	White	Loop		
Size		25mm X 25M			





Profile

Gete⁺

Gete Plus Sealing Solution

Today, Gete Plus is principally involved in the manufacture and marketing of a range of sealing solution products. These are primarily aimed at DIY and hardware distributor outlets.

Gete products were established to provide a comprehensive range of “DO IT YOURSELF” sealing and comfort products to the retail trade. We have a high level of technical expertise gained over many years in industry as a provider to the automotive trade. We have both traditional and state-of-the-art equipment and materials and we are always searching for new and better methods to satisfy our customer’s requirements. Innovation is high on our priority. We have access to the very latest in sealing technology and converting methods. This has allowed us to design a range of retail oriented products incorporating quality and value for money into each and every Gete Plus products.

Gete is unique in the way that we deliver our sealing solutions and in the way we view the method of ranging and displaying our comprehensive product range. The Gete sealing solutions reflects our commitment to the increasing demand for DIY sealing products and provides our customers with modern solutions.

Gete pioneered this unique method through researching the current methods of displaying and promoting products within this category and identified a need for a user friendly display and dispensing method that will add value to the store operator and consumer alike. Some products are offered in both individually packed retail hang packs and bulk spooled rolls dispensed by the meter.

The Gete sealing solution combines our attitude towards complete customer service and our ability to deliver the goods.

Gete Mission Statement:

Our goal is to maintain customer loyalty through superior service, quality and value. Our commitment is to continuing improvement in production and supply of quality products for our customers. Our mission will allow us to grow, deliver and best product to surpass our customer’s expectations, and thrive in a competitive region market.

Gete Vision Statement:

Confidence

Service

Technical Excellence

Cost Effective

World class performance



Gete Plus Inc.

No. 21-5, Ln. 7, Sec. 2, Zong'an St., Annan Dist., Tainan City 709040, Taiwan

Company Registration no. 64996381

Tel: +886-6-2518656

Fax: +886-6-2515661

Email: info@geteplus.com.tw

www.geteplus.com

Made in Taiwan